

# FALCON SPIDER FS 520C

Outrigger plate  
area = 2000cm<sup>2</sup>

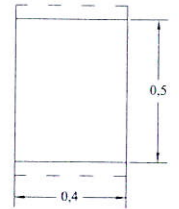

PRELIMINARY

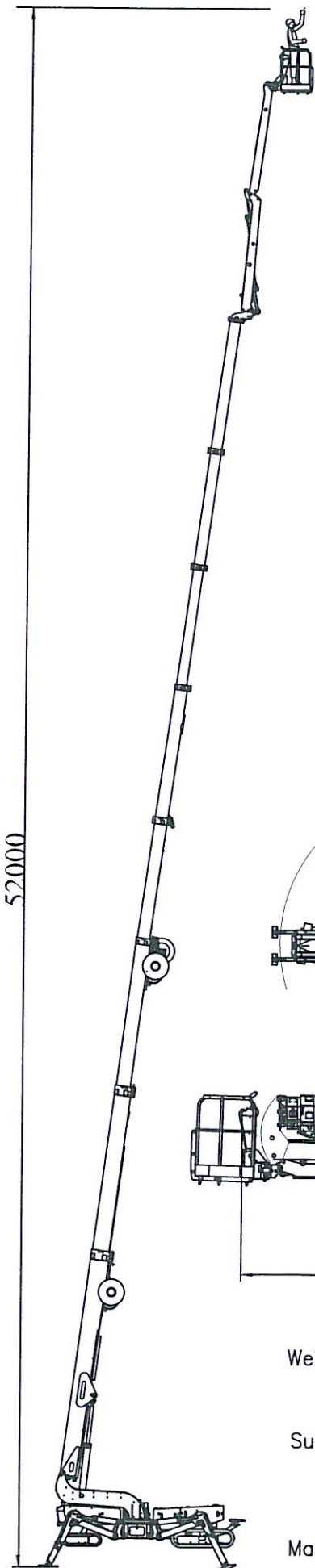
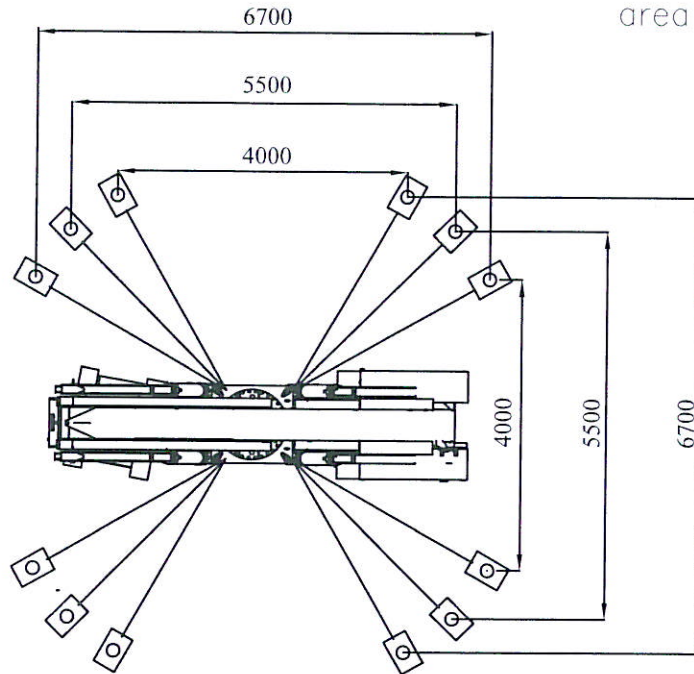

Turning radius

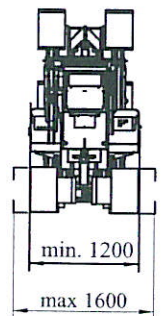
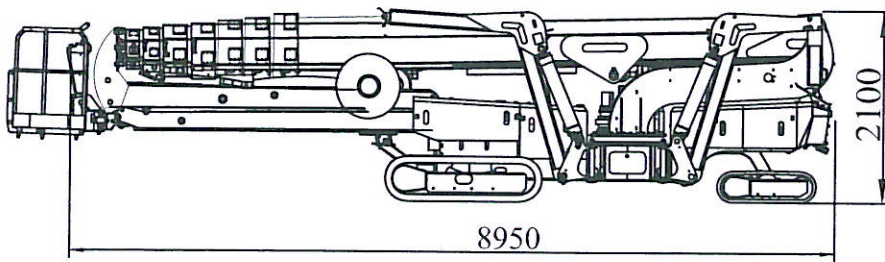
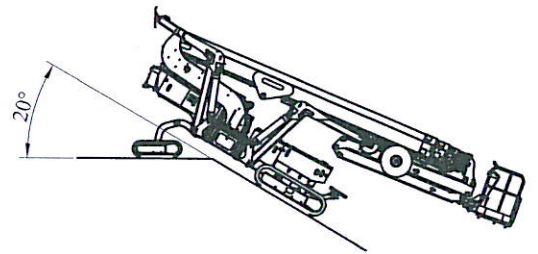
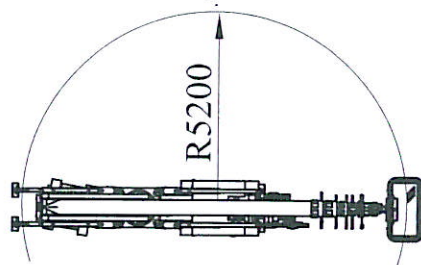

Weight standard equipment \_\_\_\_\_ 12900kg.

Surface pressure under crawlers (soft surface) \_\_\_\_\_ 2,1kg/cm<sup>2</sup>

(hard surface) \_\_\_\_\_ 6,80kg/cm<sup>2</sup>

Max. surface pressure under 1 outrigger plate \_\_\_\_\_ 4kg/cm<sup>2</sup>

# FS520C Outreach diagram.

PRELIMINARY

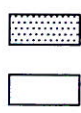
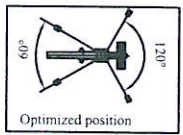
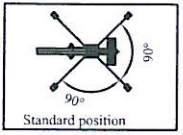
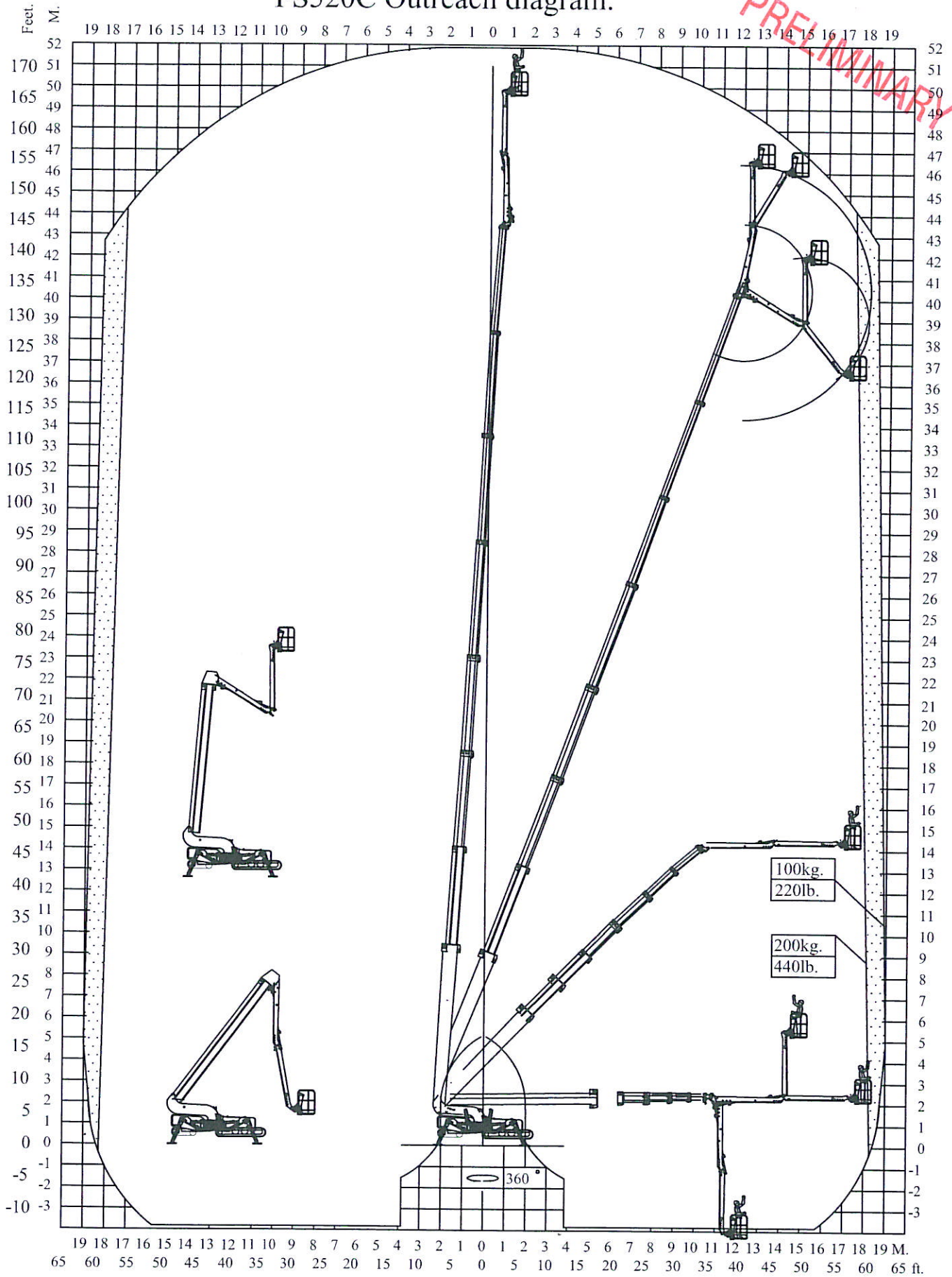

Maximum outreach with 100kg. / 220lb. within this zone depending on leg position.

Maximum outreach with 200kg. / 440lb. within this zone depending on leg position.

We reserve the right to make alternations.